

TRAMIGO

MISSION CRITICAL PUSH-TO-TALK

WELCOME

Quick Start Guide

Tramigo MCPTT



Quick Start Guide

Quick Start Guide

YOUR PTT & BUTTONS FUNCTIONS

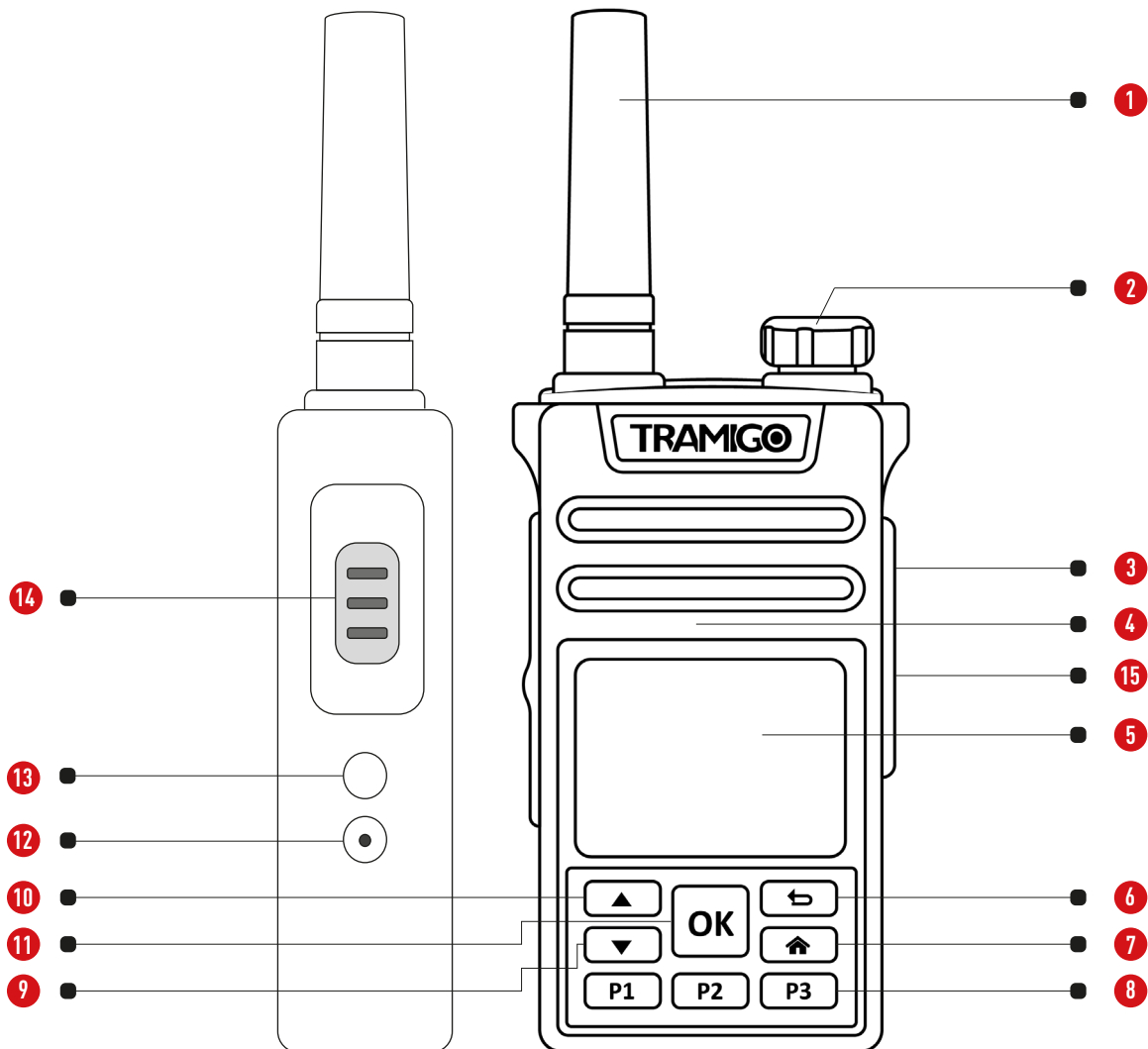

1 Antenna

2 Rotary Knob

- Press and hold to lock/unlock it.
- Rotate to set the volume
- Press and rotate to select a different talkgroup

3 Side Connector

- Provides connection for accessories

4 Speaker

5 Display

6 Back to main screen

7 Menu Key - Press to enter the main menu settings to do the following:

- Check SIM card port
- Check network APN (Please do not edit or make any changes in this field or your settings will be changed)
- Connect to wi-fi (in case of poor mobile internet connection)
- Connect to bluetooth
- Turn on/off location
- Check phone status (serial number, battery status etc)

8 Channels

9 Navigation key down

10 Navigation key up

11 Selection

12 Switch key

- Press and hold for three seconds to enter ICCID setting
- Click OK to open main menu
- Scroll down with  to feedback
- Select OK and scroll to ICCID number – ICCID number is required for troubleshooting or connecting the device to groups and platforms

13 Set up key - Applicable only with advance setup

14 PTT (Push-To-Talk)

- Press and hold to talk in simplex calls or initiate group calls
- Release it to listen

15 Charger input for charging cable

2

ATTACHING THE ANTENNA

1. Align the bottom of the antenna and the screw-in base on the top of the PTT

2. Turn clockwise until snug. Do not force

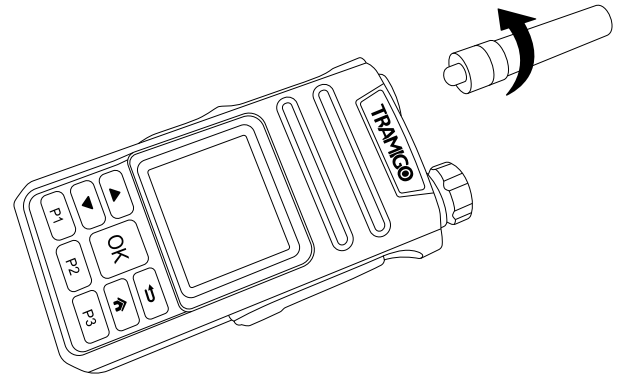

INSTALLING THE BATTERY

1. Insert the battery into the compartment.

2. Slide the battery towards the top of the PTT until it clicks

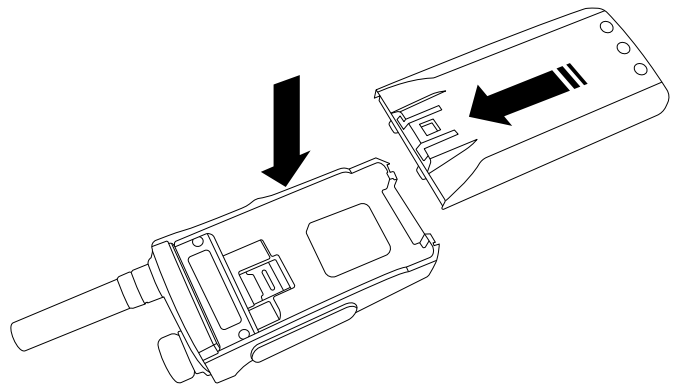

3

GETTING STARTED

Hold the PTT in a vertical position with the top microphone 5 to 10 centimeters away from your mouth.

- Press the PTT button to initiate a call
- Speak into the top microphone
- Listen via the PTT internal speaker
- In a noisy environment, move the PTT closer for better transmission

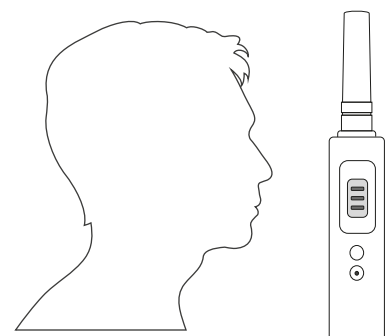







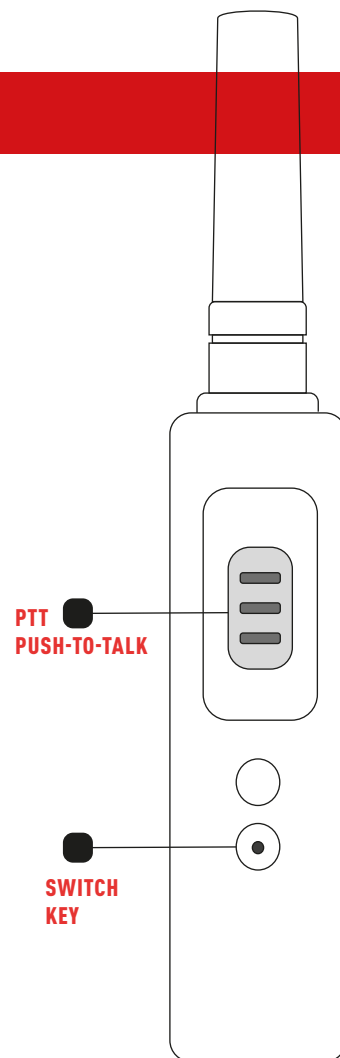



STARTING A ONE-TO-ONE CALL

This is a simple PTT session where just one caller and one recipient are involved in the conversation

1. At the main menu locate groups. Users are shown at the bottom rows as usernames
2. Press the switch key and you will be in the user's window
3. Use navigation keys  to scroll from groups to users
4. Press PTT button and select 1-1 icon to start one to one call with the recipient
5. Press the switch key again to go back to the group



DESCRIPTION

Icons	Description	Indication	Status
	Battery Charging		not connected
	Battery Level		Out of service
	Low Audio		connected
	High Audio		In use
	SIM not activated*		Switched off

* In case of no network found please contact support

LOOKING AFTER YOUR PTT

- Never leave your PTT or battery in extreme temperatures (over +85 °C), for example, behind a windscreen in direct sunlight.
- To clean your PTT, use a moistened or antistatic cloth.

QUICK START GUIDE

More Information on Tramigo MCPTT Visit the
Tramigo Web site at:

<http://www.tramigo.com>

Feature User Guide and related documentation
available upon request

customercare@tramigo.com

© Tramigo Copyright All Rights Reserved